

AIR CONDITIONER REMOTE CONTROLLER MANUAL

The design and specifications are subject to change without prior notice for product improvement. Consult with the sales agency or manufacturer for details.

CR247-RG10
16117000002081
20191008

Thank you very much for purchasing our air conditioner. Please read this owner's manual carefully before using your air conditioner. Make sure to save this manual for future reference.

CONTENTS

Remote controller Specifications.....	2
Function buttons	3
Handling the remote controller	4
Remote LCD screen indicators	5
How to use the basic functions.....	6
How to use the advanced functions	13

NOTE:

The device could comply with the local national regulations.

- In Canada, it should comply with CAN ICES-3(B)/NMB-3(B).
- In USA, this device complies with part 15 of the FCC Rules. Operation is subject to the following two conditions:
 - (1) This device may not cause harmful interference, and
 - (2) this device must accept any interference received, including interference that may cause undesired operation.

This equipment has been tested and found to comply with the limits for a Class B digital device, pursuant to part 15 of the FCC Rules. These limits are designed to provide reasonable protection against harmful interference in a residential installation. This equipment generates, uses and can radiate radio frequency energy and, if not installed and used in accordance with the instructions, may cause harmful interference to radio communications. However, there is no guarantee that interference will not occur in a particular installation. If this equipment does cause harmful interference to radio or television reception, which can be determined by turning the equipment off and on, the user is encouraged to try to correct the interference by one or more of the following measures:

- Reorient or relocate the receiving antenna.
- Increase the separation between the equipment and receiver.
- Connect the equipment into an outlet on a circuit different from that to which the receiver is connected.
- Consult the dealer or an experienced radio/TV technician for help.
- Changes or modifications not approved by the party responsible for compliance could void user's authority to operate the equipment.

Remote Controller Specifications

Model	RG10A(B2S)/BGEF
Rated Voltage	3.0V(Dry batteries R03/LR03×2)
Signal Receiving Range	8m
Environment	-5°C~60°C(23°F~140°F)

NOTE:

- Buttons design is based on typical model and might be slightly different from the actual one you purchased, the actual shape shall prevail.
- All the functions described are accomplished by the unit. If the unit has no this feature, there is no corresponding operation happened when press the relative button on the remote controller.
- When there are wide differences between "Remote controller Illustration" and "USER'S MANUAL" on function description, the description of "USER'S MANUAL" shall prevail.

Function Buttons

Before you begin using your new air conditioner, make sure to familiarize yourself with its remote control. The following is a brief introduction to the remote control itself. For instructions on how to operate your air conditioner, refer to the **How to Use Basic Functions** section of this manual.

NOTE: Please do not select HEAT mode if the machine you purchased is cooling only type. Heat mode is not supported by the cooling only appliance.

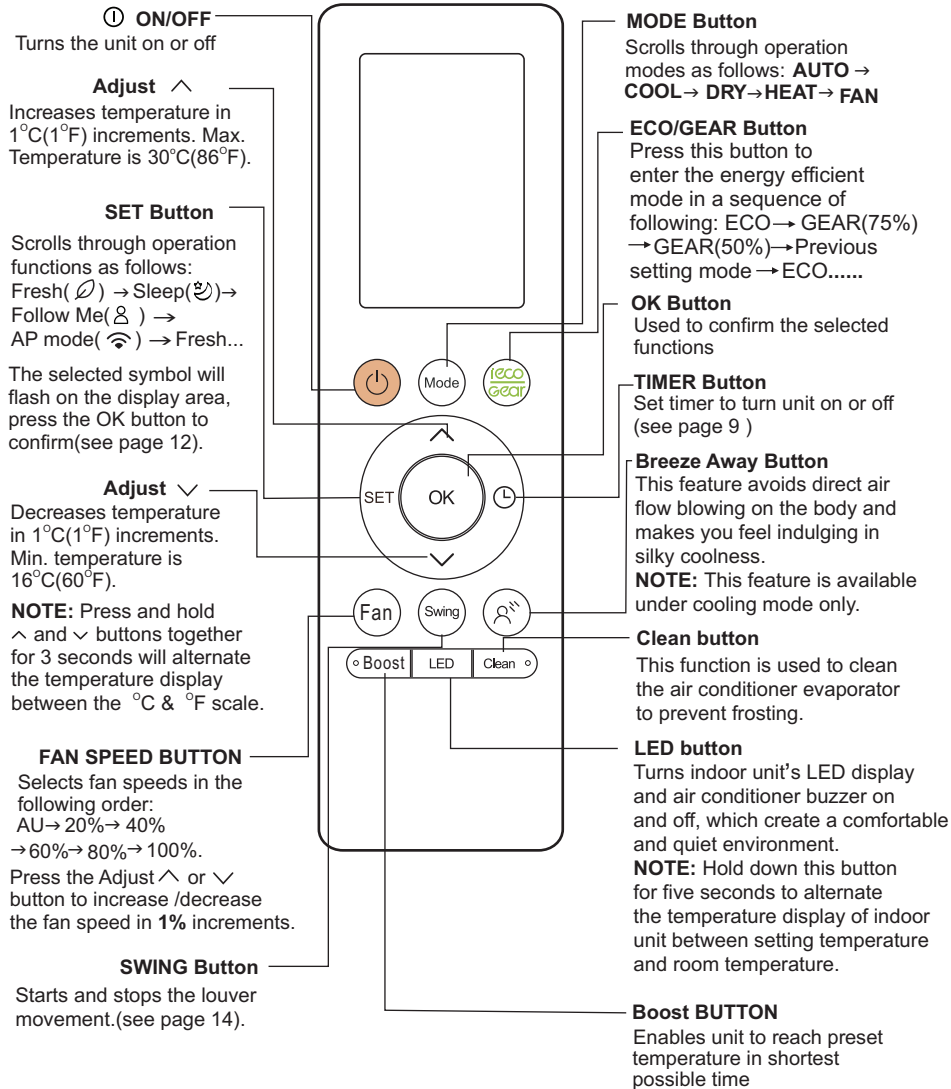

3

Handling The Remote Controller

NOT SURE WHAT A FUNCTION DOES?

Refer to the **How to Use Basic Functions** and **How to Use Advanced Functions** sections of this manual for a detailed description of how to use your air conditioner.

SPECIAL NOTE

- Button designs on your unit may differ slightly from the example shown.
- If the indoor unit does not have a particular function, pressing that function's button on the remote control will have no effect.

INSERTING AND REPLACING BATTERIES

Put the two batteries(optional parts) in the remote control before use:

1. Remove the back cover from the remote control, exposing the battery compartment.
2. Insert the batteries, paying attention to match up the (+) and (-) ends of the batteries with the symbols inside the battery compartment.
3. Install the back cover on.

INSTALLING REMOTE CONTROL HOLDER

The remote controller can be attached to a wall or stand by using a remote controller holder.

1. Before installing the remote controller, check that the air conditioner receives the signals properly.
2. Install the holder with two screws.
3. Put the remote controller on the holder.

BATTERY NOTES

For optimum product performance:

- Do not mix old and new batteries, or batteries of different types.
- Do not leave batteries in the remote control if you don't plan on using the device for more than 2 months.



BATTERY DISPOSAL

Do not dispose of batteries as unsorted municipal waste. Refer to local laws for proper disposal of batteries.

TIPS FOR USING REMOTE CONTROL

- The remote control must be used within 8 meters of the unit.
- The unit will beep when remote signal is received.
- Curtains, other materials and direct sunlight can interfere with the infrared signal receiver.
- Remove batteries if the remote control will not be used more than 2 months.

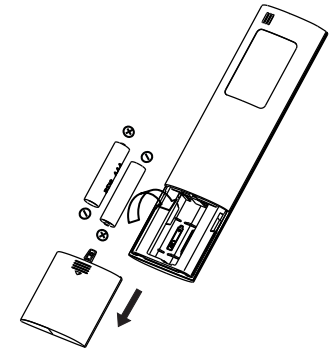

Remove the back cover to install batteries

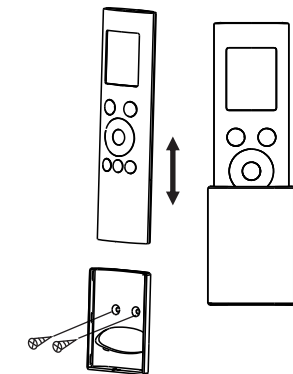

4

Remote LCD Screen Indicators

Note:

All indicators shown in the figure are for the purpose of clear presentation. But during the actual operation only the relative functional signs are shown on the display window.

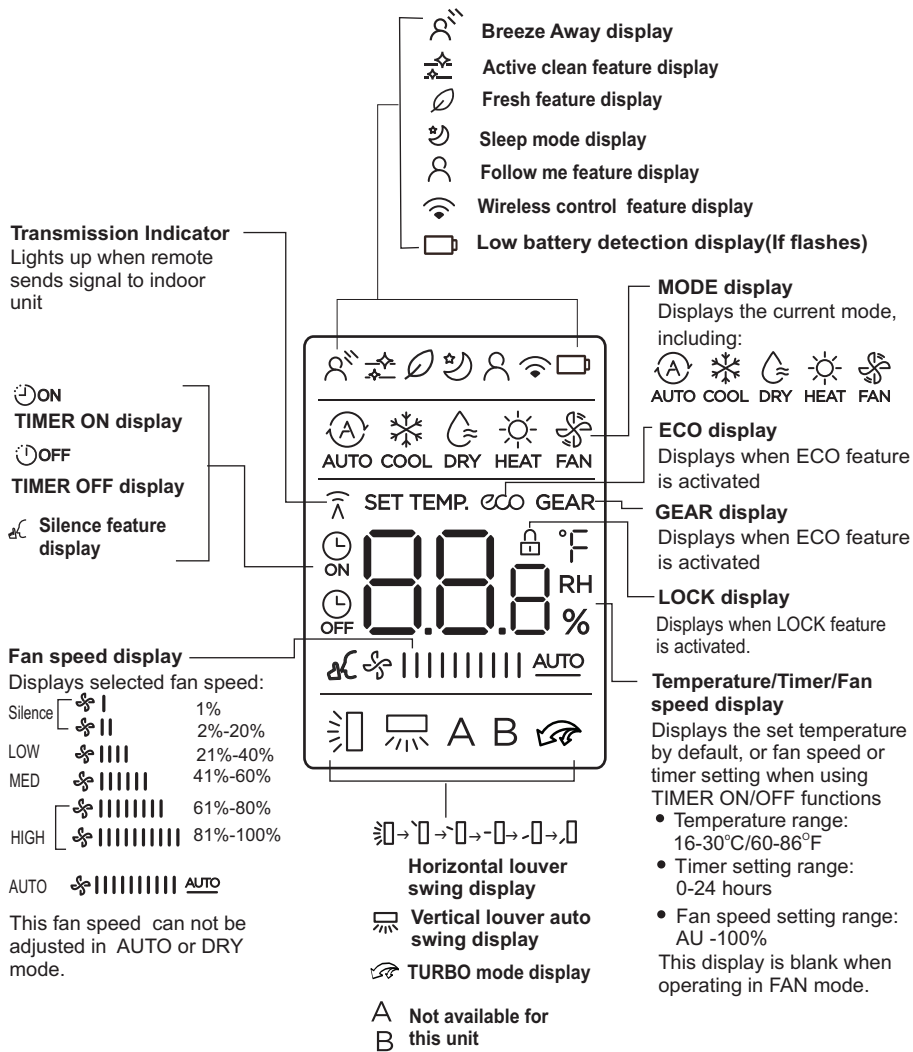

5

How To Use The Basic Functions

SETTING TEMPERATURE

The operating temperature range for units is 16-30°C/60-86°F. You can increase or decrease the set temperature in 1°C/1°F increments.

AUTO operation

In AUTO mode, the unit will automatically select the COOL, FAN, HEAT or DRY mode based on the set temperature.

1. Press the **MODE** button to select Auto mode.
2. Set your desired temperature using the **Temp ^** or **Temp v** button.
3. Press the **ON/OFF** button to start the unit.

NOTE: FAN SPEED can't be set in Auto mode.

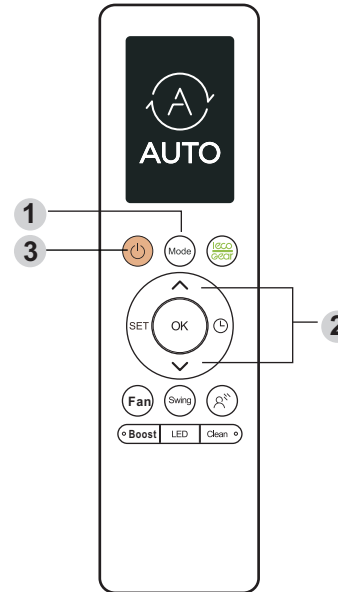

COOL operation

1. Press the **MODE** button to select **COOL** mode.
2. Set your desired temperature using the **Temp ^** or **Temp v** button.
3. Press the **FAN** button to select the fan speed in a range of Au-100%, in conjunction with **Temp ^** or **Temp v** button.
4. Press the **ON/OFF** button to start the unit.

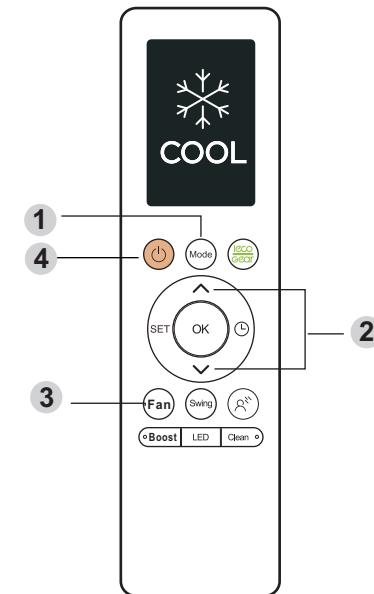

6

How To Use The Basic Functions

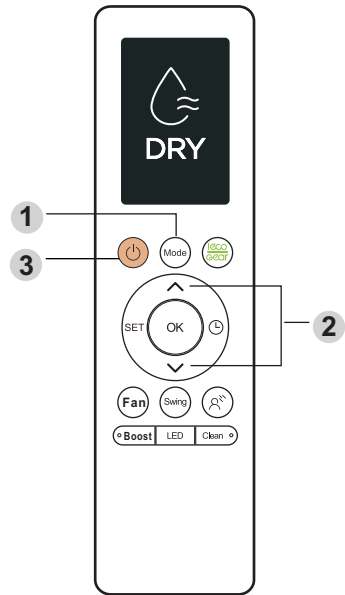

DRY operation(dehumidifying)

1. Press the **MODE** button to select **DRY** mode.
2. Set your desired temperature using the **Temp ▲** or **Temp ▼** button.
3. Press the **ON/OFF** button to start the unit.

NOTE: **FAN SPEED** can't be changed in DRY mode.

FAN operation

1. Press the **MODE** button to select FAN mode.
2. Press the **FAN** button to select the fan speed in a range of Au-100%, in conjunction with **Temp ▲** or **Temp ▼** button.
3. Press the **ON/OFF** button to start the unit.

NOTE: You can't set temperature in FAN mode. As a result, your remote control's LCD screen will not display temperature.

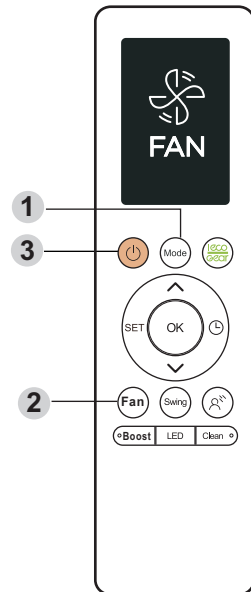

How To Use The Basic Functions

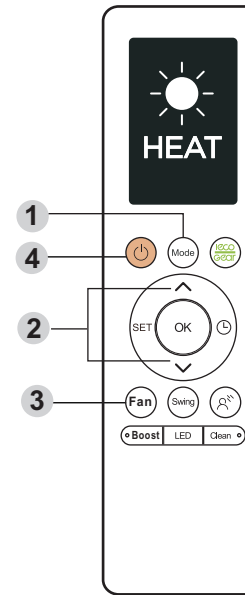

HEAT operation

1. Press the **MODE** button to select **HEAT** mode.
2. Set your desired temperature using the **Temp ▲** or **Temp ▼** button.
3. Press the **FAN** button to select the fan speed in a range of Au-100%, in conjunction with **Temp ▲** or **Temp ▼** button.
4. Press the **ON/OFF** button to start the unit.

NOTE: As outdoor temperature drops, the performance of your unit's HEAT function may be affected. In such instances, we recommend using this air conditioner in conjunction with other heating appliance.

Setting the TIMER function

Your air conditioning unit has two timer-related functions:

- **TIMER ON**- sets the amount of timer after which the unit will automatically turn on.
- **TIMER OFF**- sets the amount of time after which the unit will automatically turn off.

TIMER ON function

The **TIMER ON** function allows you to set a period of time after which the unit will automatically turn on.

1. Press the **Timer** button, the Timer on indicator "🕒" and time display.
Note: This number indicates the amount of time after the current time that you want the unit to turn on.
For example, if you set **TIMER ON** for 2.5 hours, "2.5h" will appear on the screen, and the unit will turn on after 2.5 hours.

2. Press the Temp **^** or Temp **v** button repeatedly to set the time when you want the unit to turn on.
3. Wait one second, then the **TIMER ON** function will be activated. The digital display on your remote control will then return to the temperature display. The "🕒" indicator remains on and this function is activated.

TIMER OFF function

The **TIMER OFF** function allows you to set a period of time after which the unit will automatically turn off.

1. Press the **Timer** button, the Timer off indicator "🕒" and time display.
Note: This number indicates the amount of time after the current time that you want the unit to turn off.
For example, if you set **TIMER OFF** for 5 hours, "5.0h" will appear on the screen, and the unit will turn off after 5 hours.
2. Press the Temp **^** or Temp **v** button repeatedly to set the time when you want the unit to turn off.
3. Wait one second, then the **TIMER OFF** function will be activated. The digital display on your remote control will then return to the temperature display. The "🕒" indicator remains on and this function is activated.

NOTE: When setting the **TIMER ON** or **TIMER OFF** functions, up to 10 hours, the time will increase in 30 minute increments with each press. After 10 hours and up to 24, it will increase in 1 hour increments. The timer will revert to zero after 24 hours. You can turn off either function by setting its timer to "0.0h".

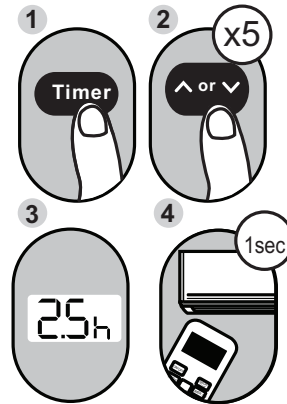

Example: Setting unit to turn on after 2.5 hours.

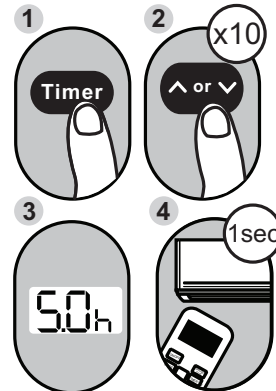

Example: Setting unit to turn off after 5 hours.

Setting both TIMER ON and TIMER OFF at the same time

Keep in mind that the time periods you set for both functions refer to hours after the current time. For example, say that the current time is 1:00 PM, and you want the unit to turn on automatically at 7:00 PM. You want it to operate for 2 hours, then automatically turn off at 9:00 PM.

Do the following:

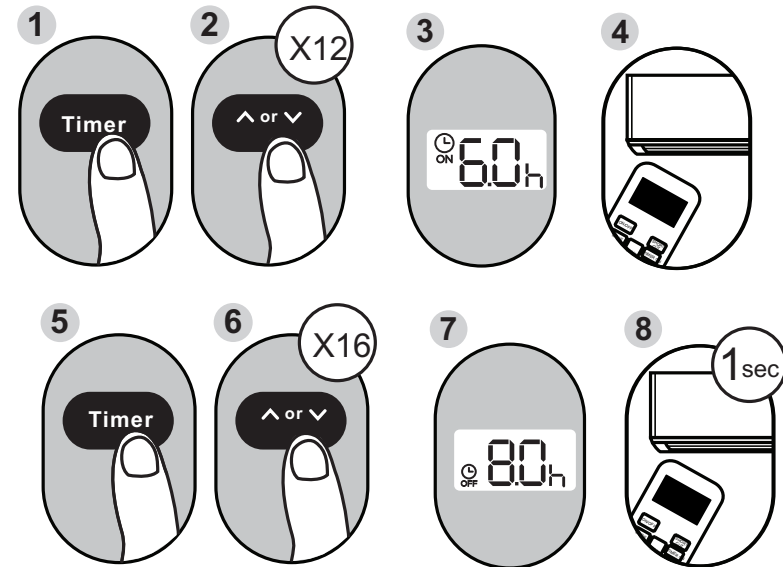

Example: Setting the unit to turn on after 6 hours, operate for 2 hours, then turn off (see the figure below)

Your remote display

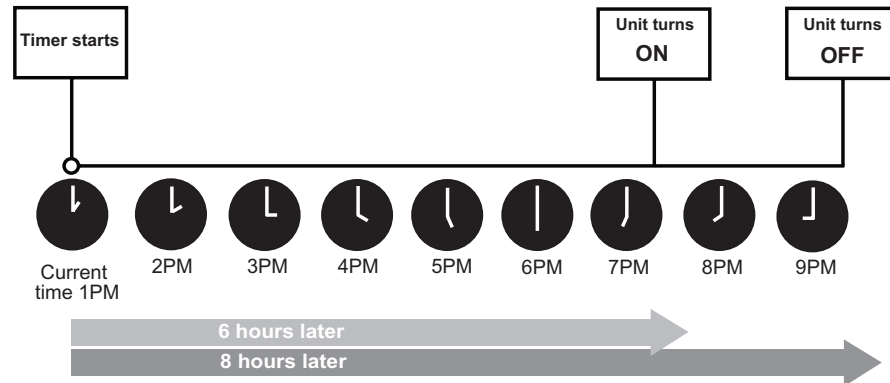
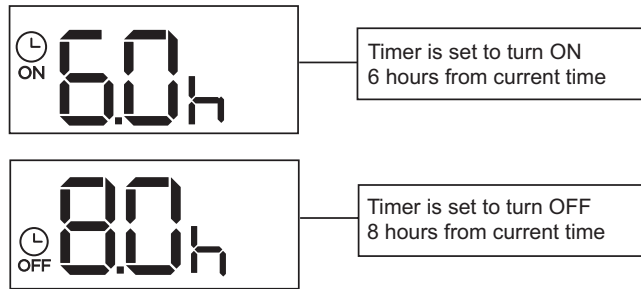

How To Use The Advanced Functions

- Press the SET button to enter the function setting, then press SET button or Temp ▼ or Temp ▲ button to select the desired function. The selected symbol will flash on the display area, press the OK button to confirm.
- To cancel the selected function, just perform the same procedures as above.
- Press the SET button to scroll through operation functions as follows:
Fresh (🍃) → Sleep (🌙) → Follow Me (📶) → AP mode (📶)

FRESH function (🍃) (optional)

When the FRESH function is initiated, the Ionizer/Plasma Dust Collector (depending on models) is energized and will help to remove pollen and impurities from the air.

SLEEP Function (🌙)

The SLEEP function is used to decrease energy use while you sleep (and don't need the same temperature settings to stay comfortable). This function can only be activated via remote control.

For the detail, see "sleep operation" in "USER'S MANUAL"

Note: The SLEEP function is not available in FAN or DRY mode.

AP mode (📶) (optional)

Choose AP mode to do wireless network configuration.

FOLLOW ME function (📶) (optional)

The FOLLOW ME function enables the remote control to measure the temperature at its current location and send this signal to the air conditioner every 3 minutes interval. When using AUTO, COOL, or HEAT modes, measuring ambient temperature from the remote control (instead of from the indoor unit itself) will enable the air conditioner to optimize the temperature around you and ensure maximum comfort.

- NOTE:** Press and hold **Boost** button for seven seconds to start/stop memory feature of Follow Me function.
- If the memory feature is activated, "On" displays for 3 seconds on the screen.
 - If the memory feature is stopped, "Of" displays for 3 seconds on the screen.
 - While the memory feature is activated, press the ON/OFF button, shift the mode or power failure will not cancel the Follow me function.

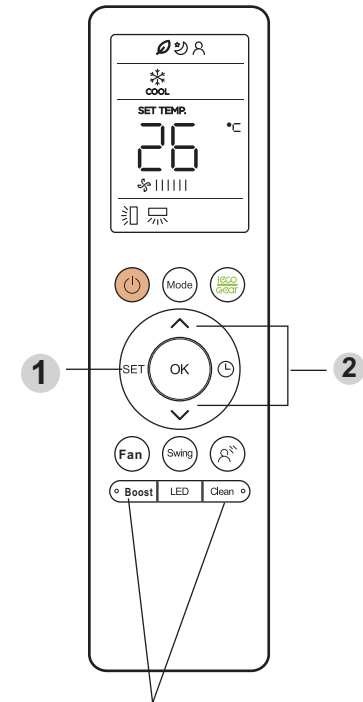

Press and hold **Boost** and **Clean** buttons together for five seconds to lock the keypads. Press and hold **Turbo** and **Clean** buttons together for two seconds to cancel.

How To Use The Advanced Functions

ECO/GEAR function()

NOTE: This function is only available under COOL mode.

- Press ECO/GEAR button to enter the energy efficient mode in a sequence of following:
ECO → GEAR(75%) → GEAR(50%) → Previous setting mode → ECO →

ECO operation:

- Under cooling mode, press this button, the remote controller will adjust the temperature automatically to 24°C, fan speed of Auto to save energy (but only if the set temperature is less than 24°C). If the set temperature is above 24°C, press the ECO button, the fan speed will change to Auto, the set temperature will remain unchanged.

NOTE:

- Pressing the ON/OFF button, modifying the mode or adjusting the set temperature to less than 24°C will stop ECO operation.
- Under ECO operation, the set temperature should be 24°C or higher. It may result in insufficient cooling. If you feel uncomfortable, just press the ECO button again to stop it.

GEAR operation:

- Press this button to enter the energy efficient mode in a sequence of following:
 75% (up to 75% electrical energy consumption)
 ↓
 50% (up to 50% electrical energy consumption)
 ↓
 Previous setting mode
- This function is only available under COOL mode.
- Under GEAR operation, the display on the remote controller will alternate between electrical energy consumption and set temperature.

Active Clean Function()

- This function is used to clean the air conditioner evaporator to prevent frosting.
- When this function is turned on, the indoor unit display window appears "CL", after 20 to 45 minutes, the unit will turn off automatically and cancel Active Clean function.

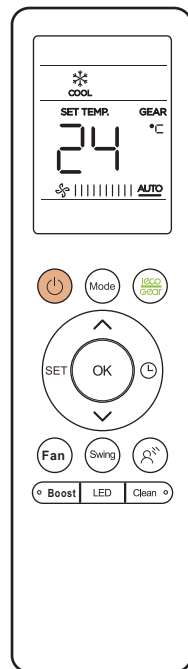

How To Use The Advanced Functions

FP function

When the air conditioner operates under heating mode with the set temperature of 16°C(60°F), pressing  button twice in one second will activate 8°C(46°F) heating. The indoor unit display shows "FP".

Silence function

Hold down Fan speed button() for 2 seconds to activate/cancel **Silent** mode. Due to low frequency operation of compressor, it may result in insufficient cooling and heating capacity (applicable to the air conditioner with Silent feature only)

Boost function()

The **Boost** function makes the unit work extra hard to reach your present temperature in the shortest amount of time possible.

- When you select **Boost** feature in **COOL** mode, the unit will blow cool air with strongest wind setting to jump-start the cooling process.
- When you select Turbo feature in **HEAT** mode, the unit will blow heat air with strongest wind setting to jump-start the heating process.

Swing function

- Press the Swing button to start or stop the horizontal louver auto swing feature. If continue to press the Swing button, five different airflow directions can be set. The louver can be move at a certain range each time you press the button.
- Hold down the Swing button for 2 seconds will start or stop the vertical louver auto swing feature.

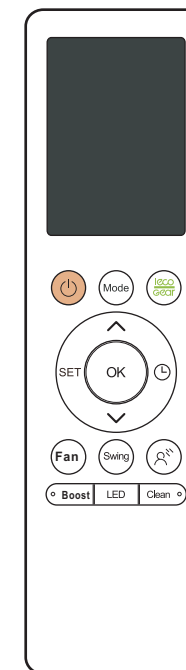

NOTE:

When the unit is off, press and hold **Mode** and **Swing** buttons together for one second, the louver will open for a certain angle, which makes it very convenient for cleaning. Press and hold **Mode** and **Swing** buttons together for one second to reset the louver.

此页无需印刷
技术要求：
80克双胶纸，
140mm*210mm
黑白

更改说明：

1. 10月8号更改，只是更改P2页上表格里的遥控器型号，改成**RG10A(B2S)/BGEF**。将封底图纸图号更改.